

1700 SERIES

HIGH PRESSURE SWIVEL



Operating Parameters

MEDIA	PRESSURE*
Water, Air, Hydraulic Fluid	5,075 PSI
TEMPERATURE*	SPEED*
248° F	80 RPM
MATERIAL	THREADS
Nickel Plated Steel	<ul style="list-style-type: none"> ■ 1/4" to 3" NPT ■ BSP & BSPP Available

* See Performance Charts For Details

Features & Benefits

High Pressure Applications

High pressure swivel for use in hydraulic and pneumatic applications.

Corrosion Resistant

Standard models feature nickel treated carbon steel construction, but are also available in all stainless steel.

GR Seal Technology

Equipped with a GR seal, which is suitable for most fluids.

Thrust Bearings

A single acting thrust bearing permits slow rotation at high pressures.

1700 SERIES HIGH PRESSURE SWIVEL

PART NUMBERS	Nominal Pipe Size (DN)	Shaft Thread (A)	Part Number	Description
		1/4"	1/4"	750788C
	3/8"	3/8"	750789C	R1817SRKNPT
	1/2"	1/2"	750790C	R1821SRKNPT
	3/4"	3/4"	750791C	R1827SRKNPT
	1"	1"	750792C	R1834SRKNPT
	1-1/8"	1-1/4"	750793C	R1842SRKNPT
	1-1/2"	1-1/2"	750794C	R1849SRKNPT
	1-3/4"	2"	750795C	R1860SRKNPT
	2-1/4"	2-1/2"	750796C	R1876SRKNPT
	2-3/4"	3"	750797C	R1890SRKNPT

MAXIMUM OPERATING PRESSURE (psi)

Nominal Pipe Size (DN)	Shaft Thread (A)	Maximum Pressure (PSI)
1/4"	1/4"	5,075
3/8"	3/8"	5,075
1/2"	1/2"	4,350
3/4"	3/4"	4,350
1"	1"	3,625
1-1/8"	1-1/4"	3,625
1-1/2"	1-1/2"	2,900
1-3/4"	2"	2,900
2-1/4"	2-1/2"	2,175
2-3/4"	3"	2,175

1700 SERIES HIGH PRESSURE SWIVEL (in.)								
DIMENSIONS	Nominal Pipe Size (DN)	Shaft Thread (A)	B	C	Overall Length (F)	G	Flats (H)	Overall Diameter (I)
	1/4	1/4	1/2	7/16	2-5/8	1-3/4	1/2	1-1/4
	3/8	3/8	1/2	1/2	2-3/4	1-15/16	1/2	1-1/2
	1/2	1/2	5/8	9/16	3-1/8	2-3/16	3/4	2-1/16
	3/4	3/4	3/4	5/8	3-1/2	2-1/2	1	2-1/4
	1	1	7/8	3/4	3-3/4	2-9/16	1-1/4	2-1/2
	1-1/8	1-1/4	1	3/4	4-1/8	2-3/4	1-1/2	3
	1-1/2	1-1/2	1	3/4	4-9/16	3-1/8	1-3/4	3-3/8
	1-3/4	2	1-1/8	1	4-13/16	3-1/4	2-1/4	4
	2-1/4	2-1/2	1-1/8	1	5-1/2	3-3/4	2-3/4	5-1/8
2-3/4	3	1-1/4	1-1/8	7-1/8	4-13/16	3-3/8	6-1/8	

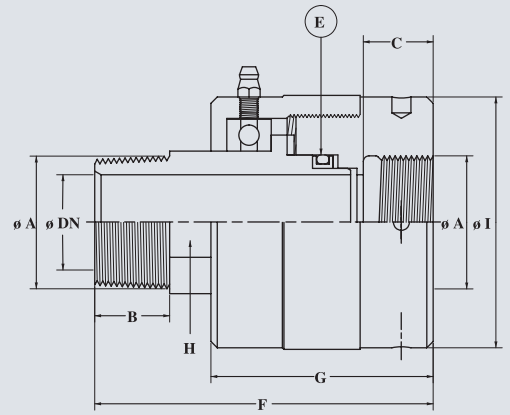

Performance Charts

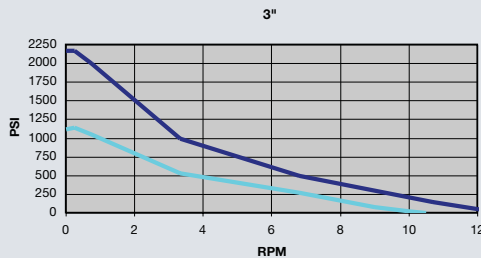
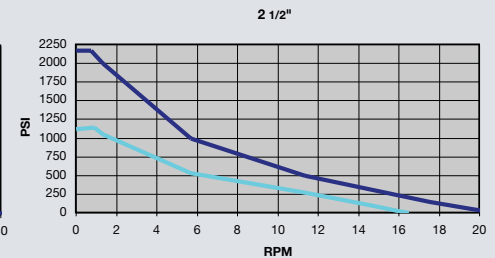
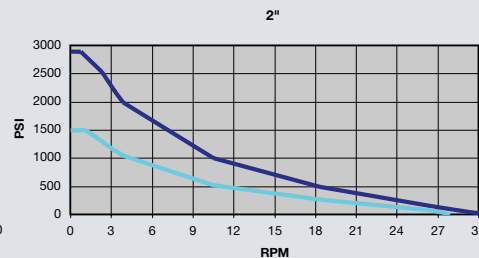
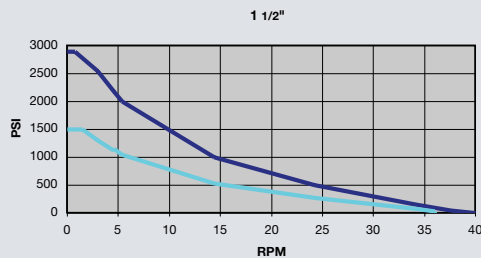
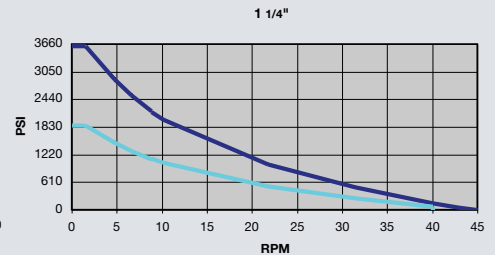
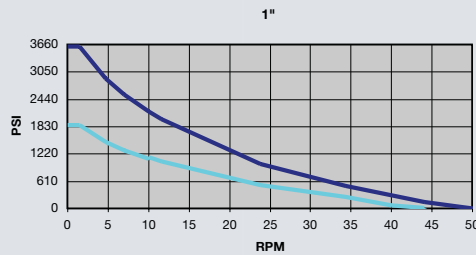
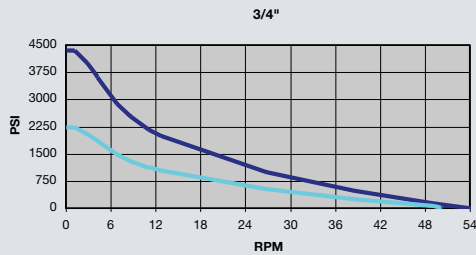
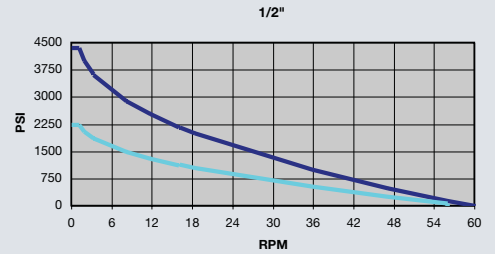
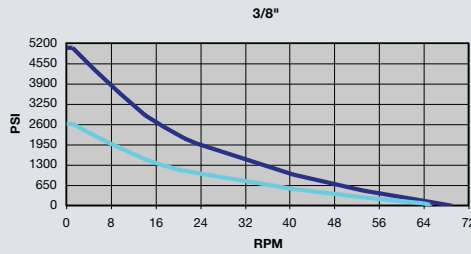
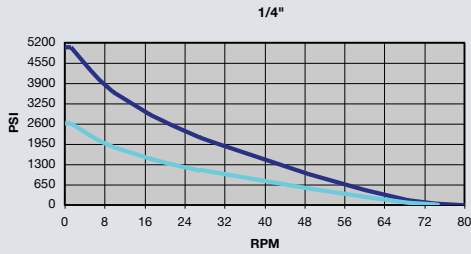

Standard Materials

Stainless Steel